

Article number: 12712000100700
Description: KLEE-coil 712 000 100.700
M10 Light-alloy metal

Measures

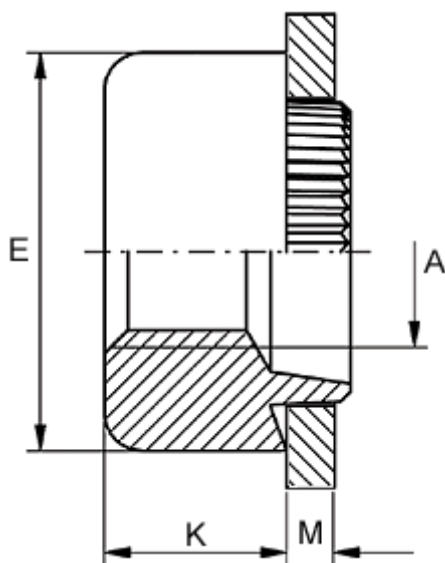

Female thread A	= M10
Height K	= 8.0
Outer diameter E	= 19.0
Plate thickness	= 3.2 to 3.4
Recommended bore diameter for extreme load	= 15.0
Recommended bore diameter for normal use	= 16.0